



# MINI

## Datasheet

### MINI | Industrial Computer

DYNICS MINI series features four different minicomputers (Standard, Extended, Sealed IP50, and Desktop), equipped with a Braswell quad core processor and aluminum heatsinks. Making these compact computers powerful and effective in industrial environments; suited for a multitude of production applications.

#### Key Features

- Braswell
- Fan-less (No Moving Parts)
- Optional 2x Wi-Fi Ports (MINI-X Only)
- Aluminum Heatsink
- UL Listed
- Din Rail and Bracket Mounting Options
- 24VDC

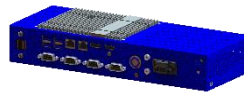

#### PC Specifications

Motherboard:	MINI-S	MINI-E	MINI-X	MINI-D
<b>Product</b>	<b>Standard</b>	<b>Extended</b>	<b>Sealed IP50</b>	<b>Desktop</b>
<b>I/O</b>	2x 1Gb Ethernet Ports 4x USB 3.0 Ports 1x DisplayPort 1x HDMI Port 2x RS232 Ports 1x RS232/422/485 Port 2x Audio Jacks (Mic-In/Line-Out)	2x 1Gb Ethernet Ports 4x USB 3.0 Ports 2x USB 2.0 Ports 1x DisplayPort 1x HDMI Port 3x RS232 Ports 1x RS232/422/485 Port 2x Audio Jacks (Mic-In/Line-Out)	2x 1Gb Ethernet Ports 4x USB 3.0 Ports 2x USB 2.0 Ports 1x DisplayPort 1x HDMI Port 1x RS232 Port 1x RS232/422/485 Port 2x Audio Jacks (Mic-In/Line-Out)	2x 1Gb Ethernet Ports 4x USB 3.0 Ports 1x DisplayPort 1x HDMI Port
<b>CPU</b>	Braswell N3160			
<b>CPU Speed</b>	1.6GHz Base, 2.24GHz Turbo (4 Cores, 4 Threads)			
<b>Memory</b>	Up to 8GB DDR3			
<b>Power Supply</b>	24VDC Power Entry			
<b>Storage</b>	128GB mSATA SSD (MINI-S, MINI-D), 240GB – 480GB SATA SSD (MINI-E, MINI-X)			
<b>Operating System</b>	- Windows® 7 Professional (64-bit) - Windows® 7 Embedded (64-bit) - Windows® 10 Enterprise IoT LTSB 2016 (64-bit) – Linux Ubuntu (Image Setup for RDP Login)			
<b>Temperature</b>	Operating: 0° - 50°C (32° - 122°F) Non-Operating: -25° - 60°C (-13° - 140°F)			
<b>Relative Humidity</b>	Non-Condensing: 20% - 80%			
<b>Shock</b>	Operating: 10G Non-Operating: 15G			
<b>Vibration</b>	Operating: 1.0G from 57~2000Hz Non-Operating: 2.5G from 57~2000Hz			
<b>Included</b>	1x Set of DIN Rail Mounts 1x Panel Mount Brackets 1x DisplayPort-to-VGA adapter			
<b>Compliance</b>	USA: UL 60950-1 (UL Listed), FCC 47 CFR Part 15, Class A Canada: CSA C22.2 No. 60950-1-07 (cUL Listed), ICES-001, Group 1, Class A European Union CE: EN 60950-1, EN 61326-1, CISPR 11, Group 1, Class A European Union Directive 2011/65/EU (RoHS)			
<b>Warranty</b>	24-Month limited warranty. Extended warranty available, contact DYNICS for details.			





# MINI

## Datasheet

### Dimensions, Weights and Power Consumptions

	Height:	Width:	Depth:	Weight:	Power Consumption:
<b>MINI-S</b>	2.125" (54.0mm)	8.460" (214.9mm)	4.697" (119.3mm)	5 lbs.*	25 Watts**
<b>MINI-E</b>	2.000" (50.8mm)	12.000" (304.8mm)	4.500" (114.3mm)	7 lbs.*	25 Watts**
<b>MINI-X</b>	1.889" (47.9mm)	7.875" (200.0mm)	5.511" (140.0mm)	3 lbs.*	25 Watts**
<b>MINI-D</b>	1.551" (39.3mm)	10.210" (259.3mm)	4.697" (119.3mm)	2 lbs.*	25 Watts**

\*Weights are approximate, contact DYNICS for details.

\*\*Power Consumption based on maximum ratings, actual ratings vary significantly based on components used.

### Mechanical Drawings

#### MINI-S

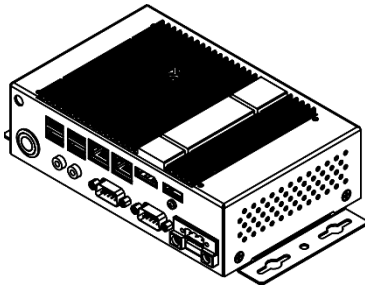

#### Top View

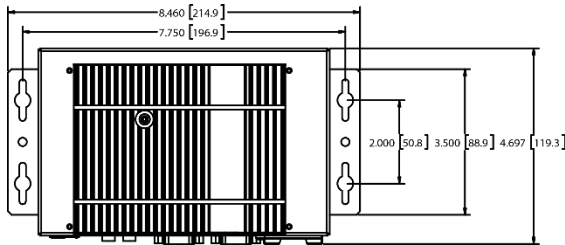

#### Front View

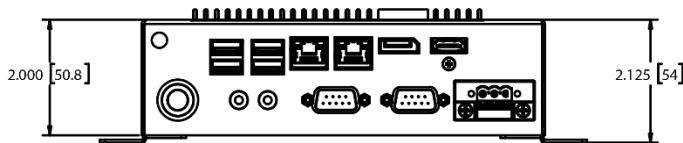

#### Bottom View

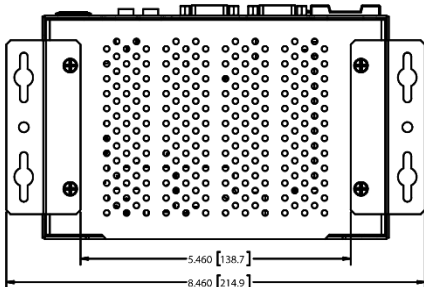

#### MINI-E

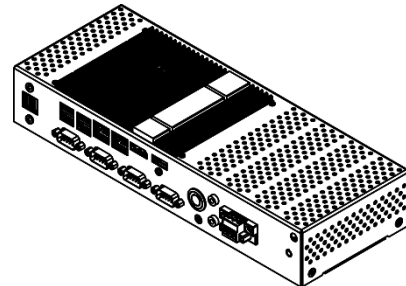

#### Top View

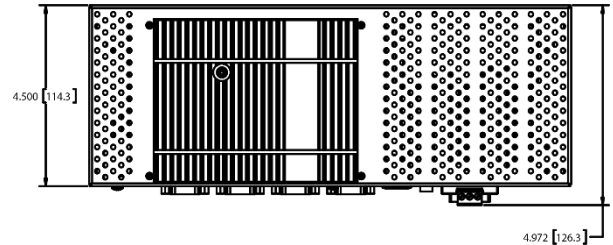

#### Front View

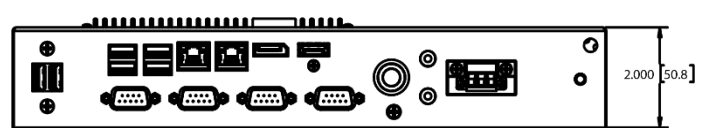

#### Bottom View

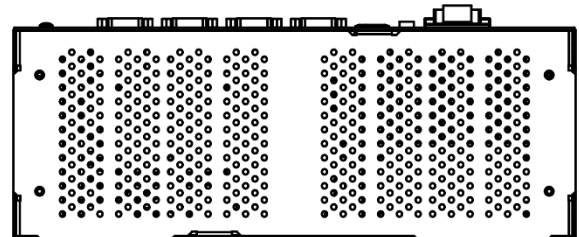



# MINI

## Datasheet

### MINI-X

### MINI-D

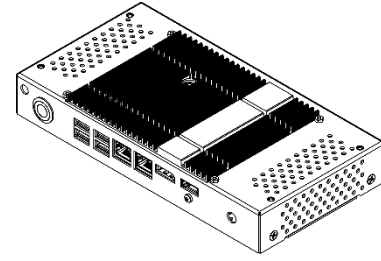
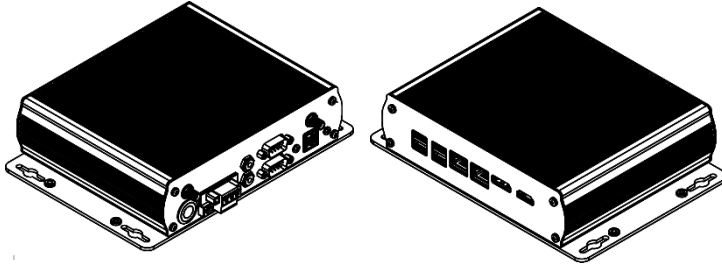

Top View

Top View

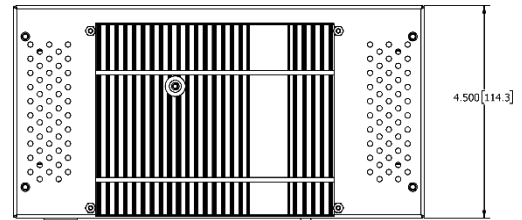
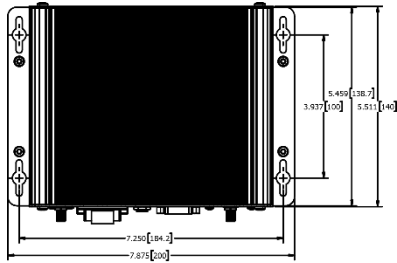

Front View

Front View

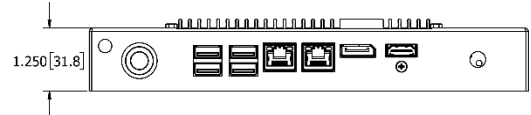
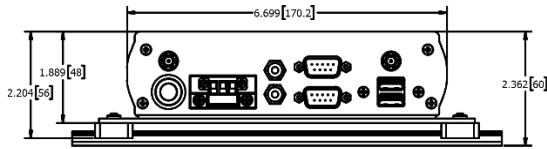

Bottom View

Bottom View

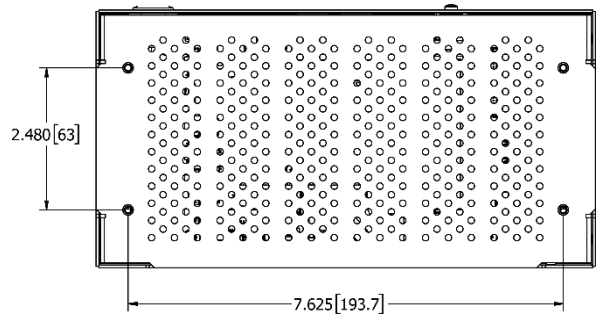
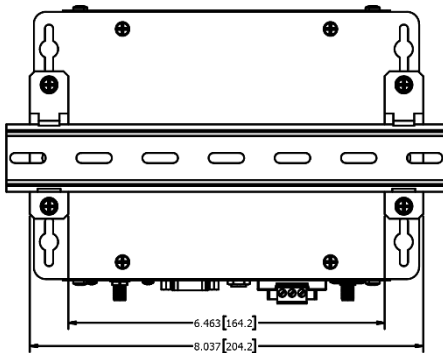

All measurements are in inches and pounds, unless noted. Pictures and drawings are not to scale. Estimated weight may change depending on options. DYNICS reserves the right to change, modify, upgrade, or discontinue any part of this datasheet without any prior notice.

